

***BOSE***<sup>®</sup>

# AVIATION HEADSET X

Owner's Guide





## DECLARATION OF CONFORMITY

We, the offerer:

**Bose Corporation,**

**The Mountain, Framingham, MA 01701-9168 USA**

Acknowledge our sole responsibility, that the product:

**Kind of equipment:** Bose® Aviation Headset X

**Type Designation:** AHX-32-0# and AHX-34-0#

In accordance with EMC Directive 89/336/EEC  
and Article 10(1) of the Directive,  
is in compliance with the following  
norm(s) or documents(s)

Technical regulations: EN55013, EN55020

Accredited by:

Bose Corporation, The Mountain, Framingham, MA  
01701-9168 USA

15 June 2003

Nic Merks

Bose Products B.V.  
Nijverheidstraat 8, 1135 GE Edam  
The Netherlands

Vice President, Europe  
Manufacturer's authorized  
EU representative

## Operational advisory

The Bose® Aviation Headset X is an active noise reducing (ANR) headset. As with any complex electronic device, it is possible for this headset to fail during operation. Symptoms of failure may include loud tones, distortion, and loss of communications signal in the headset when used in the ANR mode.

**Note:** The headset includes redundant circuitry to reduce the effects of such failures and allow for continued use of the headset in the ANR mode.

If you experience loud tones and the related loss of communications, turn off the power switch. The headset will continue to provide communications in the passive noise-reducing mode.

ANR mode is active when the headset control module power switch is set to ON (Figure 1) or when the battery power indicator is lit. The headset is in the passive mode when the power switch is set to OFF, or when the battery power indicator is unlit.

**Figure 1**

On/Off switch on (a) the battery powered headset and (b) the aircraft powered headset

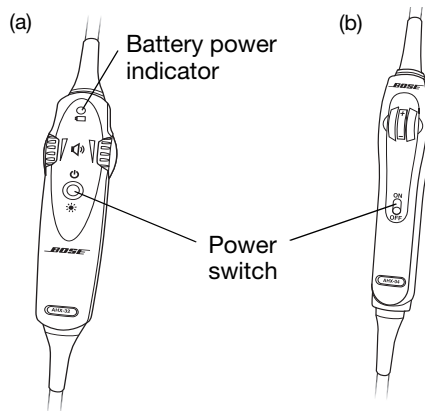

## Power source

Your headset is one of two types: battery powered, or aircraft powered.

If your headset is battery powered, make sure it is connected only to battery power. If your headset is aircraft powered, connect the headset to the aircraft power sources only as described in this guide.

An aircraft powered headset will not operate properly if used with a Bose Series II Aviation Headset battery pack or with any commercial battery pack.

## ***How use of the headset affects hearing safety***

The headset is intended for use with ANR turned on. Noise reduction and communications performance are reduced with ANR turned off.

### ***Volume control***

Make sure your aircraft communications system volume control is easily accessible. This control affects the strength of the communications signal coming into the headset, whether ANR is on or off.

As pilot in command, you must be sure you can understand critical communications even with ANR off. In this case, you may need to turn up the aircraft communications system volume.

Avoid setting the volume controls at levels high enough to impair your hearing during extended periods of headset use.

### ***Listening to the sounds of your aircraft***

With the headset's active and passive noise reduction, typical aircraft sounds (from engines, propellers, warning alarms, and other sound sources) may not sound familiar. We strongly advise you to make sure you can hear and recognize these sounds when using the Bose® Aviation Headset X while operating any aircraft.

### ***Using entertainment audio sources***

When listening to in-flight entertainment or a home audio source through a Bose Aviation Headset X, be sure to limit the volume to safe levels that do not interfere with your ability to hear informational sounds and warning alarms, such as stall warnings or gear up, while piloting.

## ***Other cautions***

### ***TriPort® headset earcup requirements***

Proper headset operation requires that the TriPort headset openings on the earcup are kept free of debris. The TriPort headset openings (Figure 2 on page 5) are located on the outside of each earcup and are comprised of two holes and a screen.

**Figure 2**

*TriPort® headset openings*

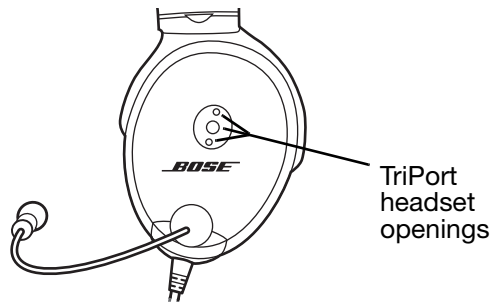

### **Earcup inner screen**

The protective inner screen is critical to the headset's ability to reduce noise (Figure 3).

**Figure 3**

*Protective inner screen  
inside the earcup*

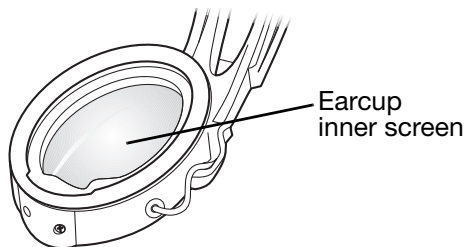

Do not attempt to remove, replace, or repair this screen. If operating problems indicate the need for screen replacement, contact the Bose® Aviation Headset Department. Refer to “Contact information” on page 34.

If the screen gets wet or any foreign objects become lodged on or adjacent to it, follow the instructions in “Headset Care and Maintenance” on page 25.

### **Storage**

Do not store the headset in an unventilated area or in direct sunlight. If your headset is battery powered, remove the batteries before storing the headset for extended periods.

# CONTENTS

---

Cautions and Advisories . . . . .	3
Operational advisory . . . . .	3
Power source . . . . .	3
How use of the headset affects hearing safety . . . . .	4
Volume control . . . . .	4
Listening to the sounds of your aircraft . . . . .	4
Using entertainment audio sources . . . . .	4
Other cautions . . . . .	4
TriPort® headset earcup requirements . . . . .	4
Earcup inner screen . . . . .	5
Storage . . . . .	5
Contents . . . . .	6
Introduction . . . . .	8
We appreciate your choice . . . . .	8
Headset and cable variations . . . . .	8
Getting Your Headset Ready for Use . . . . .	10
Locate the serial number for your product registration card . . . . .	10
Date of manufacture . . . . .	10
Decide where you want the boom microphone . . . . .	10
Removing an attached boom microphone cable . . . . .	11
Attaching the boom microphone cable . . . . .	11
Clothing clip . . . . .	12
Preparing to use battery power . . . . .	13
Changing the optional operation switches . . . . .	13
Inserting batteries . . . . .	14
Preparing the aircraft powered headset for use . . . . .	14
Attaching and removing the cable . . . . .	14
Mounting the connector . . . . .	15
Details on making the connections . . . . .	16
Use proper adhesives . . . . .	17
Mono, stereo, and helicopter connection diagrams . . . . .	18
Using Your Headset. . . . .	19
Wearing it properly . . . . .	19
Conditions related to fit . . . . .	19
Microphone placement . . . . .	20
Operating the battery powered headset . . . . .	20
Power button . . . . .	21
Volume control . . . . .	21
Notice the individual earcup controls . . . . .	21
Controlling the volume of a single battery powered headset . . . . .	22
Volume control using multiple headsets . . . . .	22
Battery power indicator . . . . .	22

Operating the aircraft powered headset . . . . .	23
Power switch . . . . .	23
Volume control . . . . .	23
Notice the individual earcup controls . . . . .	24
Controlling the volume of a single aircraft powered headset . . . . .	24
Volume control using multiple headsets . . . . .	24
Headset Care and Maintenance . . . . .	25
Instructions for continued airworthiness . . . . .	25
Cleaning the headset . . . . .	25
General cleaning . . . . .	25
Earcup TriPort® headset openings . . . . .	25
Ear cushions . . . . .	26
Microphone windscreen . . . . .	26
Earcup inner screen . . . . .	26
Replacement parts . . . . .	26
Headband cushion . . . . .	27
Removing environmental moisture . . . . .	27
Replacing parts . . . . .	27
Microphone windscreen replacement . . . . .	27
Ear cushion replacement . . . . .	27
Battery replacement . . . . .	28
Battery door replacement . . . . .	29
Headband cushion replacement . . . . .	29
Boom microphone cable or connector access cover replacement . . . . .	29
Troubleshooting . . . . .	30
In case of difficulty . . . . .	30
Technical Information . . . . .	32
FAA Technical Standards Order . . . . .	33
Service & Warranty Information . . . . .	34
Warranty period . . . . .	34
Service . . . . .	34
To return your headset to Bose for repair . . . . .	34
Contact information . . . . .	34
Ordering parts and accessories . . . . .	35

### ***We appreciate your choice***

Congratulations on your purchase of a Bose® Aviation Headset X.

This headset combines Bose Acoustic Noise Cancelling® headset technology to electronically reduce unwanted aircraft noise, and Bose TriPort® headset technology for a smaller, lighter, more comfortable headset that delivers full-spectrum noise reduction.

We believe it is the finest aviation headset you can own.

### ***Headset and cable variations***

The Bose Aviation Headset X is available in variations designed for general aviation and helicopter use. There are also battery powered and aircraft powered versions (Figure 4 on page 9).

The communications cable for your headset may be either straight or coiled, depending on the headset configuration you have purchased.

### ***Features common to most variations:***

- Acoustic Noise Cancelling headset technology
- TriPort headset technology
- Communications cable with integrated control module
- Flexible microphone boom with continuous position adjustments
- Adjustable headband
- Replaceable ear cushions
- Replaceable fleece headband cushion
- Replaceable windscreen
- Cable-mounted clothing clip



**Figure 4**

The (a) battery powered and (b) aircraft powered versions of the headset

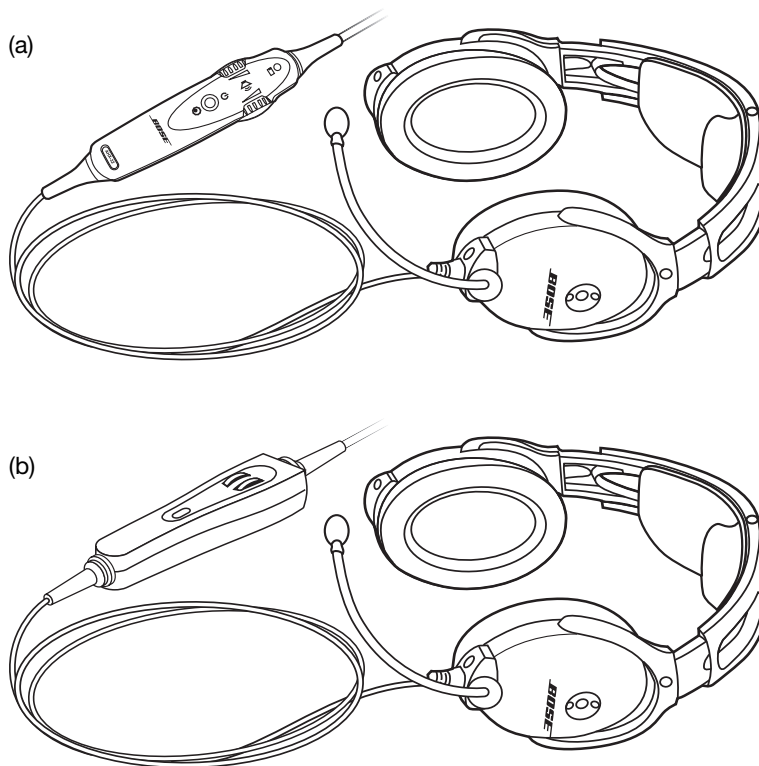

## GETTING YOUR HEADSET READY FOR USE

---

### **Locate the serial number for your product registration card**

The Bose® Aviation Headset X includes a product registration card in the carton.

Please fill in the requested information and mail it to Bose. We will use this information to provide you with appropriate advisories and updates. Be sure to include your headset serial number, which can be found on the barcode label located on the underside of the magnesium headband, underneath the headband cushion.

#### **Figure 5**

Locating the serial number under the headband cushion

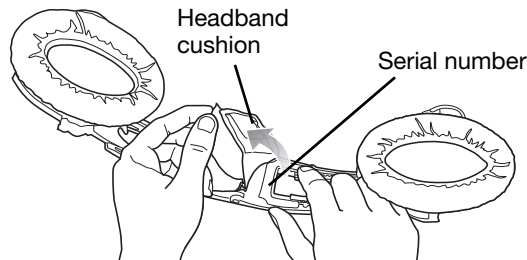

After locating your headset serial number, be sure to properly replace the headband cushion by pressing down firmly. For more information on replacing the headband cushion, see “Headband cushion replacement” on page 29.

### **Date of manufacture**

Your headset’s date of manufacture is an important part of your serial number. It is the underlined, four-digit number that begins just after the first alphabetic letter in the serial number.

Example: 031963E31920040E

In this example, the date of manufacture is 3192. The first digit, 3, refers to the year of manufacture (2003). The last three digits, 192, refer to the day of the year (the 192<sup>nd</sup> day of 2003).

### **Decide where you want the boom microphone**

Depending on the headset configuration you purchased, your headset may arrive with the boom microphone cable attached to the left earcup or packed separately in the carton.

In either case, you can attach the boom microphone cable to either earcup, as preferred.

Before you remove or attach the microphone, however, be sure to note the important markings for left (L) and right (R) above each earcup. These markings indicate which ear each earcup is intended to fit over.

### **Removing an attached boom microphone cable**

1. Use a Phillips or straight blade screwdriver to loosen the two screws at the base of the boom microphone cable assembly.
2. Pull the cable assembly straight out from the earcup to which it is attached (Figure 6).

**⚠ CAUTION:** Do not twist the boom microphone cable while disconnecting it. Twisting can damage the connector pins.

**Figure 6**

*Pulling the cable assembly straight out from the earcup*

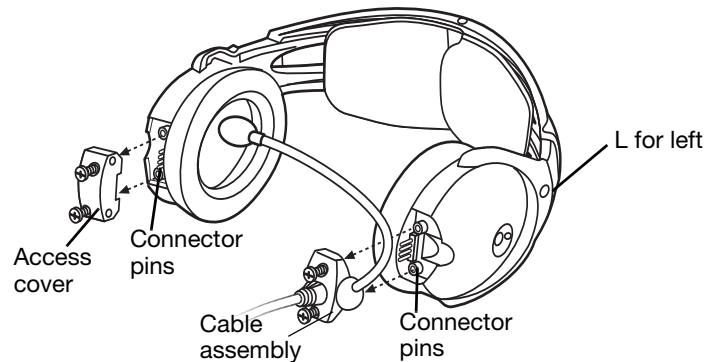

### **Attaching the boom microphone cable**

Before you attach the boom microphone, make sure that the cable connector and its earcup connector are clean and free of debris.

1. Use a Phillips or straight blade screwdriver to loosen the two screws on the access cover near the bottom of the earcup where you want to attach the boom microphone.
2. Remove the cover to reveal the connector pins on the earcup.
3. Carefully line up the connector to the small connector pins on the panel (Figure 7 on page 12).

**⚠ CAUTION:** An improperly aligned connector will not make the connections necessary for proper operation, and may cause damage.

**Figure 7**

Positioning the mic cable assembly on the preferred earcup

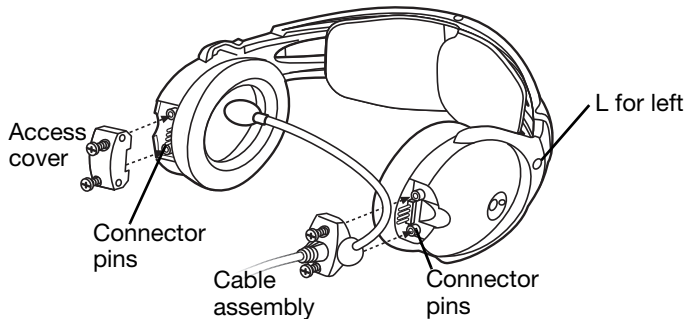

4. Press the assembly onto the connector pins until it is fully engaged and the cable assembly is flush with the earcup.

**⚠ CAUTION:** Do not apply excessive force, which may result in earcup damage.

5. With the screw threads properly aligned, tighten the screws.
6. Rotate the microphone boom into position so it will be near your mouth when you put on the headset. The label should be facing your lips.
7. Attach the access cover to the connector panel on the earcup that does not have the boom mic attached. Align the screws and tighten them to secure the cover.
  - If you moved the boom mic from one earcup to the other, reuse the access cover you removed earlier.

**⚠ CAUTION:** Be sure to try the headset and test its operation before flight.

### Clothing clip

Use the clothing clip (Figure 8) for attaching the control module to your clothing, a safety harness, or an aircraft door pocket. Pressing on the end of the clip allows you to reposition it along the cable.

**Figure 8**

Moving the clothing clip along the cable



**⚠ CAUTION:** Do not attempt to clip onto surfaces that are more than  $\frac{1}{4}$ -inch thick.

## Preparing to use battery power

The battery compartment on your headset control model serves two purposes. In addition to holding the batteries, it contains small switches (Figure 9) that give you the option to change some of the factory-set operation defaults for your headset. Refer to “Battery replacement” on page 28 for information on opening the battery compartment.

**Figure 9**

Optional operation switches inside the battery compartment

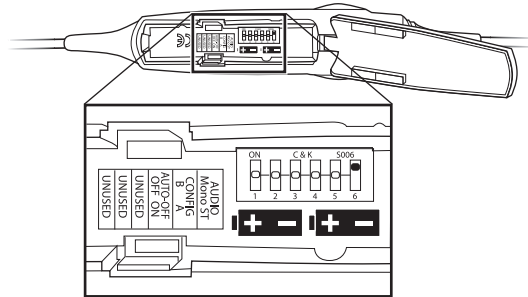

### Changing the optional operation switches

**Note:** To change switch positions, use a pen or a small, flat-tipped screwdriver to gently switch the tab.

- Switches 1- 3: Not currently used.
- Switch 4: Set at the factory to enable the smart shutoff function. To disable smart shutoff, set switch to OFF. With the switch in OFF position, the ANR system will not turn off until the power button is depressed and held for at least one second.

**Note:** The smart shutoff function is designed to detect when the headset is not in use and shut off ANR to preserve battery power. Smart shutoff turns off circuitry several minutes after you remove the headset.

- Switch 5: Set to A at the factory for operation with new headsets. Set it to B if you are installing a portable cable onto an older, existing Aviation Headset X that was manufactured before June, 2003.

**Note:** If you cannot determine the manufacture date of your headset, refer to “Locate the serial number for your product registration card” on page 10.

- Switch 6: Set at the factory for mono audio systems (to provide audio in both ears). Set it for stereo (ST) if your aircraft has a stereo intercom.

### **Inserting batteries**

Insert the two supplied alkaline AA batteries (IEC LR6) into the control module (Figure 10).

**Figure 10**

*Installing the two batteries*

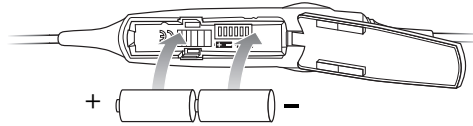

**⚠ CAUTION:** *The battery compartment is designed to prevent inadvertent reverse polarity from installing the batteries incorrectly. If the batteries do not seem to fit correctly, do not force them in. Forcing an improper connection will cause permanent damage to the control module.*

### **Preparing the aircraft powered headset for use**

For permanent installation of the headset, the harness (material number 323172-0010) is installed into the aircraft. The 3-foot wiring harness includes a self-latching, precision designed, quick-connector for panel mounting in the aircraft. The connector is mechanically keyed to ensure proper mating. To order additional harnesses, call Bose at 1-800-242-9008.

Note: The aircraft panel connector must be mounted and documented by qualified personnel to perform this type of avionics installation into the aircraft being used. Consult your local FAA office or aviation authorities to determine the appropriate documentation required.

The Bose connector (material number 323172-0010) is TSO approved (C-57a and C-58a) together with the Bose Series II Aviation Headset and the Bose Aviation Headset X.

### **Attaching and removing the cable**

When the quick-connector is installed, the cable leading from the control module connects to it. Match the narrow bar on the cable end to the slot on the connector. Press in until the two parts engage (Figure 11 on page 15).

To release the cable, pull back on the sleeve near the end of the cable. Then gently remove the cable from the connector.

**CAUTION:** Do not attempt to pull the connector out without first pulling back on the sleeve. Forcing the connector out will cause damage to the cable and/or your aircraft instrument panel.

**Figure 11**

Attaching and removing the cable

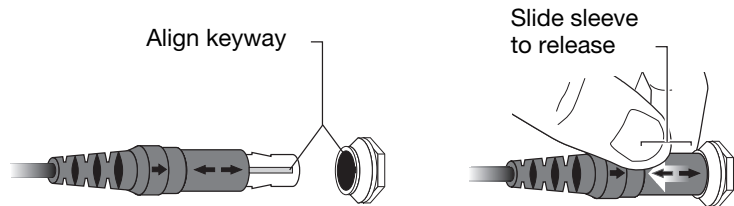

### Mounting the connector

Mount the connector into a cutout, as shown in Figure 12 below. Connect the eight wires as follows:

- Two for the microphone
- Two for audio
- One for power
- One for ground
- Two for audio shields

Audio and microphone wires should be connected to the back of the existing microphone and headphone jacks, leaving existing jacks intact for use with conventional headsets. This is usually the fastest installation method (see Figures 1 – 4 for reference). Audio shields should be connected to ground at the existing jack.

(Caution: Use of two headsets wired in parallel is not advised. This may result in reduced performance.)

**Figure 12**

Harness connector and schematic

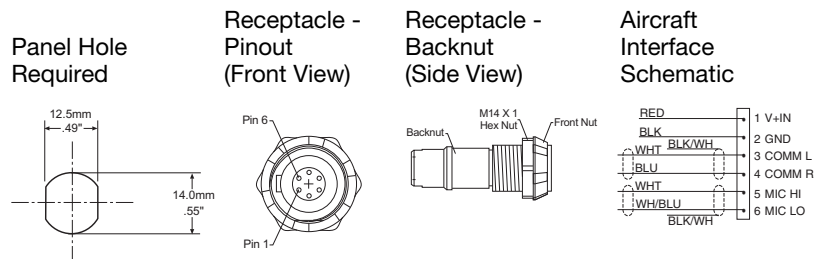

***Details on making the connections***

The pinout for the optional installed connector is:

<u>Pin</u>	<u>Wire color</u>	<u>Description</u>
1	Red	Headset power (10-32 VDC). Use a 1/4 amp fuse or a 1/2 amp circuit breaker.
2	Black	System ground. Connect to the existing audio ground.
3	White	Phone communication – L
4	Blue	Phone communication – R
5	White	Microphone/Hi-audio. Connect to the portion of the existing microphone jack that corresponds to the ring position of a headset microphone plug. Do not connect to the tip (PTT) segment.



### **Notes**

- For use with a stereo intercom, connect the left and right channels to their respective positions. If your intercom provides a monaural audio signal, connect pins 3 & 4 together to the tip of the existing phone jack.
- Do not use excessive force or bend the installed connector. This may damage or break internal solder joints.
- If the boom microphone works on radio transmit but not through the intercom, check pin 6. It may be incorrectly wired to the PTT segment of the microphone jack.
- The wires connecting pins 3 & 4 and pins 5 & 6 are shielded, twisted pairs with a shield termination exiting with a black/white wire for each pair. Connect shields to existing audio wiring shields or to audio ground, if existing wiring is not shielded.
- The Bose aircraft panel connector cannot be installed to an audio system using transformer-coupled audio outputs. Call the Bose Aviation Headset Department for details: 800-287-0611.
- Connecting power directly to pins 5 or 6 will result in damage to the microphone.
- The wire guage is 22 AWG.

### ***Adhesives approved for use with this connector are:***

- VTCS-6 Vibratite
- Three Bond 1401

Do not let cyanoacrylate-based adhesives, flux remover, or other caustic compounds contact the connector body. These chemicals cause irreparable damage to the connector.

**Mono, stereo, and helicopter connection diagrams**

**Figure 13**

Diagram of connections for a mono signal

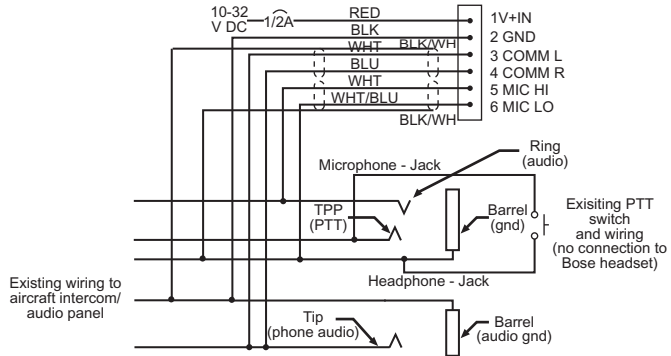

**Figure 14**

Diagram of connections to aircraft stereo jacks

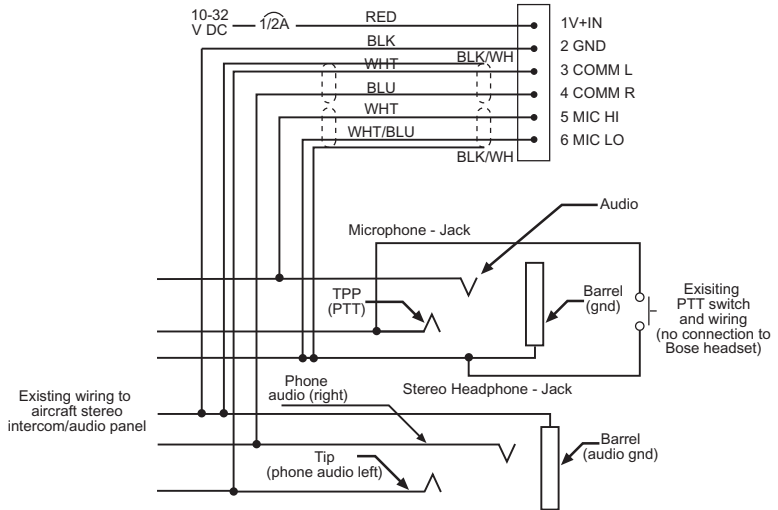

**Figure 15**

Diagram of connections to a helicopter single jack

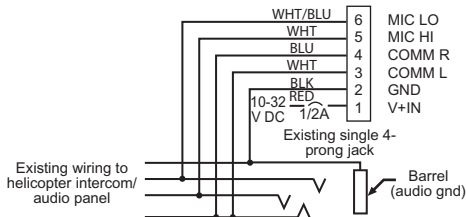

**Note:** Barrel ground (gnd) refers to aircraft grounds

## Wearing it properly

Proper fit on your head is important both for comfort and good noise reduction performance. Here are a few guidelines:

- Use the left (L) and right (R) markings above the earcups to orient the headset properly (Figure 16).

**Figure 16**

*Matching the R and L markings to your right and left ears*

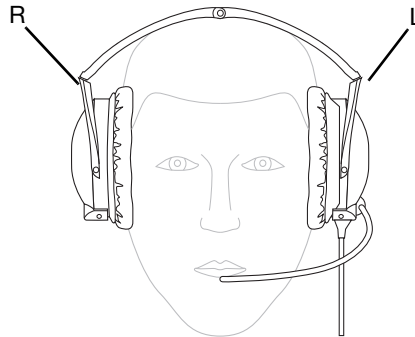

- Use a light grasp to adjust each earcup so its cushion is completely over your ear and you feel an even, gentle pressure all around it.
- Adjust the headband so it rests gently on top of your head.

Make your final adjustments in a noisy environment and with the power switch set to ON.

### **Conditions related to fit**

A low rumbling sound or frequent brief losses of active noise reduction (ANR) may indicate an improper fit or blocked earcup ports. Refer to “Headset Care and Maintenance” on page 25 for instructions on how to deal with a blockage.

In very loud conditions, such as during takeoff, you may experience brief reductions in ANR as the headset compensates for a momentary pressure change. If this problem continues when the sound level returns to normal, however, refer to “In case of difficulty” on page 30. If the problem persists, contact the Bose® Aviation Headset Department for assistance.

During a long flight, you may feel a slight pressure point, which can be relieved by adjusting the headband position.

Your experience with using the headset will help establish a sense of how it should sound and feel.

### **Microphone placement**

Proper microphone placement is important for clear communications. With the headset on your head, make these adjustments:

1. Grasp the boom with your fingers and move the microphone up or down so it is level with your mouth (Figure 17).

**Figure 17**

*Properly placing the microphone, (a) wide side nearly touching your mouth, not (b) farther away or (c) tilted*

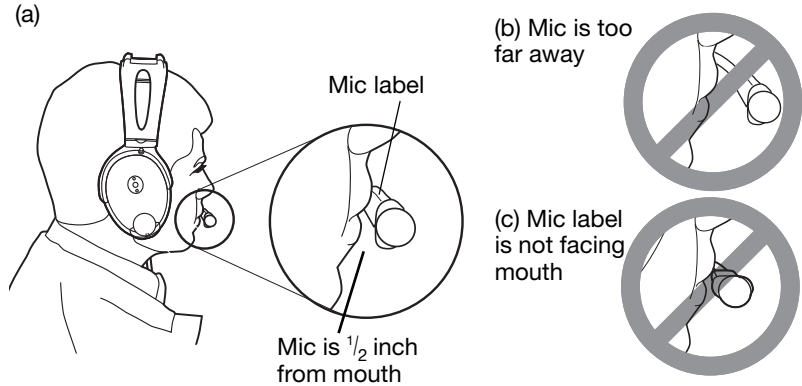

2. Pull the microphone in toward your lips. Position the microphone with its label side facing in. Though it will be slightly off center, the microphone should be 1/2 inch from the opening of your lips.
3. Make sure the broad side of the microphone is facing your lips. Do not purse your lips.

### **Operating the battery powered headset**

If your headset is battery powered, read the control information below. If your headset is aircraft powered, refer to “Operating the aircraft powered headset” on page 23.

The battery powered headset uses **AdaptiSense™** headset technology to supply the power your headset needs at any given time. Smart shutoff turns off the circuitry several minutes after you remove the headset.

This maximizes available energy for longer life from the two batteries. A tri-color LED provides real-time battery status. Its brightness is adjustable for day/night operation.

## Power button

Use the power button to turn the headset on or off, or to change the LED brightness (Figure 18).

- Press the power button once to turn on ANR.
- Press and hold the power button to turn off ANR.  
Or rely on the smart shutoff feature (described on page 13).

**Note:** For details on how to disable smart shutoff, see “Changing the optional operation switches” on page 13.

- Press twice rapidly to toggle between the daytime (brighter) and nighttime (dimmer) LED settings.

**Figure 18**

The LED, volume control knobs, and power switch on the control module of a battery powered headset

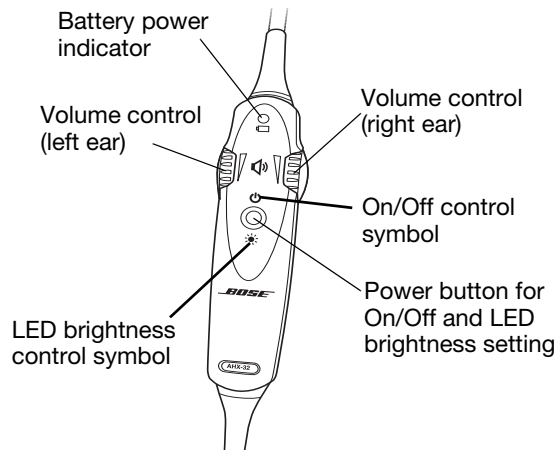

## Volume control

### Notice the individual earcup controls

Separate knobs on the control module control the volume for each separate earcup (Figure 18).

Overall headset volume control requires adjustments at both the aircraft intercom or radio and at the headset control module. Even at its lowest setting, neither knob on the control module can completely turn off the volume.

**CAUTION:** Avoid setting the volume levels too high. Exposure to loud sounds may cause hearing damage.

Holding the control module upright and facing you:

- Use the left knob to adjust volume in the left earcup.
- Use the right knob to adjust volume in the right earcup.

### **Controlling the volume of a single battery powered headset**

With ANR on:

1. Set the aircraft communication system to a safe operating level.
2. Turn each volume knob on the headset control module down to decrease, or up to increase the volume of the earcup it controls.

### **Volume control using multiple headsets**

When an aircraft has more than one headset connected to its audio system, the pilot in command should adjust the volume of his/her Bose® Aviation Headset  $\times$  as follows:

1. Turn off ANR by setting the power switch to OFF.
2. Turn each volume knob on the headset control module up to its maximum setting.
3. Adjust the master volume on your aircraft intercom or radio until you can hear communications clearly.

**Note:** *This should be done in a noisy environment.*

4. Adjust the volume knobs on the headset control module to balance the volume between the left and right earcups.
5. Turn ANR back ON.
6. Turn down the aircraft intercom or radio master volume to the level you prefer.

After the pilot's headset volume is set, passengers may adjust the volume of their headsets. Have them follow steps 1 and 2. See "Controlling the volume of a single aircraft powered headset" on page 24.

### **Battery power indicator**

New alkaline AA batteries (IEC LR6) will generally supply 30 to 40 hours of power for the headset. Battery life varies with the ambient noise level of the aircraft, temperature, ear cushion condition, and age of the batteries.

An LED, located on the control module, changes color to indicate the power status, as follows:

<i>LED Color</i>	<i>Type of light</i>	<i>Indicates</i>
Green	Blinking	Power ON and batteries good
Amber	Fast blinking	Power ON, but batteries low (8 hours or less remaining)
Red	Faster blinking	Power ON, but batteries very low (2 hours or less remaining)
Off	None	Power OFF or batteries discharged

## **Operating the aircraft powered headset**

### **Power switch**

Turn on ANR by setting the power switch to ON (Figure 19).

#### **Figure 19**

*The volume control knobs and power switch on the aircraft powered headset control module*

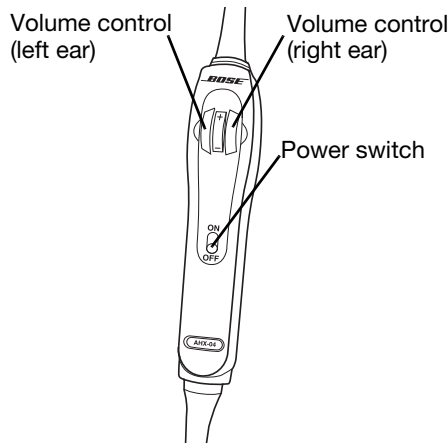

### **Volume control**

Overall headset volume control requires adjustments at both the aircraft intercom or radio and at the headset control module. Even at its lowest setting, neither knob on the control module can completely turn off the volume.

**⚠ CAUTION:** *Avoid setting the volume levels too high. Exposure to loud sounds may cause hearing damage.*

### **Notice the individual earcup controls**

Separate knobs on the control module control the volume for each separate earcup (Figure 19 on page 23).

Holding the control module upright and facing you:

- Use the left knob to adjust volume in the left earcup.
- Use the right knob to adjust the volume in the right earcup.

### **Controlling the volume of a single aircraft powered headset**

With ANR turned on:

1. Set the aircraft communication system to a safe operating level.

**Note:** *If you are connecting the headset to your aircraft for the first time, turn down the master output level of your radio/intercom system to avoid exposure to high volume levels.*

2. Turn each volume knob on the headset control module down to decrease, or up to increase the volume of the earcup it controls.

### **Volume control using multiple headsets**

When an aircraft has more than one headset connected to its audio system, the pilot in command should adjust the volume of his/her Bose Aviation Headset X as follows:

1. Turn off ANR by setting the power switch to OFF.
2. Turn up each volume knob on the headset control module to its maximum.
3. Adjust the master volume on your aircraft intercom or radio until you can hear communications clearly.

**Note:** *This should be done in a noisy environment.*

4. Adjust the knobs on the headset control module to balance the volume between the left and right earcups.
5. Turn ANR back ON.
6. Reduce the master volume on the aircraft intercom or radio to the level you prefer.

After the pilot's headset volume is set, passengers may adjust the volume of their headsets. Have them follow steps 1 and 2 under "Controlling the volume of a single aircraft powered headset" above.



## Instructions for continued airworthiness

Bose recommends following the general care and maintenance instructions in this guide. With normal use, items such as wind-screens and ear cushions may require periodic replacement. If cleaning or replacement of these items is needed, follow the recommendations on the following pages. All other care and maintenance, in and out of the warranty period, must be performed by Bose or an authorized dealer. Other maintenance is performed by condition only.

**⚠ CAUTION:** Do not immerse the headset in water or any other liquid.

## Cleaning the headset

Clean only those parts listed below according to the instructions.

### General cleaning

Gently wipe the outside surfaces of the headband, connectors, plastic parts, and headband cushion, using a soft cloth moistened with water and mild soap. Take special care when cleaning the ear cushions and the outside surfaces of the earcups, as described below.

### Earcup TriPort® headset openings

The TriPort headset openings, shown in Figure 20, must remain clean and free of debris. Check to be sure that openings are clean before each flight.

**Figure 20**

*TriPort headset openings on one earcup*

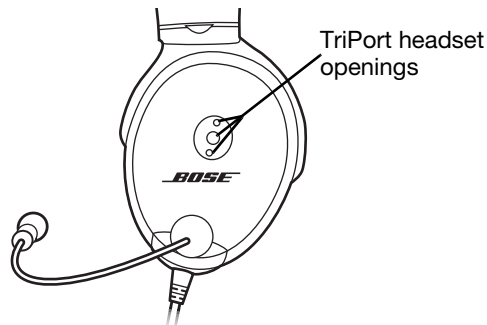

When wiping down the headset, be sure not to force any dirt or debris into the openings. Carefully use tweezers, if necessary, to remove foreign matter that may be lodged in the openings. Do not blow air into or vacuum the openings.

### ***Ear cushions***

As a general rule, ear cushions should be replaced every six months or every 350 hours of use, depending on how often you fly. You may have to replace them more often, if you:

- have a full beard or heavy whiskers
- subject the headsets to severe temperature extremes such as parking your airplane outside in severe cold or heat
- put excess strain on the headset due to improper storage

Indications that the ear cushions need replacing include:

- flaking of the outer covering
- cuts or tears
- flattening of the cushion, reducing the effectiveness of the seal

To extend the life of the ear cushions, perform regular cleaning as described in “General cleaning” on page 25.

If the ear cushions require more vigorous cleaning, remove them from the earcups, as shown in “Replacing parts” on page 27. Do not immerse ear cushions in water or any other liquid.

### ***Microphone windscreen***

Remove the windscreen from the microphone as described in “Microphone windscreen replacement” on page 27.

Wash the windscreen by immersing in mild soapy water. Rinse, air-dry, and reattach the windscreen.

### ***Earcup inner screen***

*Do not* attempt to remove, replace, repair, or clean this component. Located inside the earcup, the inner screen is critical to proper headset operation. If the screen appears to cause operating problems, contact the Bose® Aviation Headset Department.

### ***Replacement parts***

Replacement parts can be ordered directly from Bose Corporation. Please refer to “Contact information” on page 34.

### ***Headband cushion***

1. Remove the cushion as described in “Headband cushion replacement” on page 29.
2. Place the cushion in a solution of water and a mild detergent.
3. Allow the cushion to air dry, then, reattach.

### ***Removing environmental moisture***

If the protective inner screen becomes damp, due to environmental moisture such as light rain, dew, perspiration, or condensation, allow it to air dry only. Do not use electric heaters, blowers, or hairdryer type devices to dry the inner screen.

If the headset is immersed in liquid, do not use it. Contact the Bose® Aviation Headset Department for assistance.

## ***Replacing parts***

Through normal use, parts like windscreens and ear cushions may require periodic replacement.

### ***Microphone windscreen replacement***

1. Remove the band that secures the windscreen by rolling the band from the tip of the microphone.
2. Gently pull the windscreen off of the microphone.
3. Slide-on the replacement windscreen and make sure that it fits completely over the microphone.
4. Roll a new band to the proper position, about  $\frac{1}{4}$  inch from the end of the windscreen, to secure it.

### ***Ear cushion replacement***

1. Grasp the ear cushion skirt where it folds into the slot on the earcup (Figure 21).
2. Gently pull the ear cushion skirt up and away from the earcup.

**Figure 21**

*Pulling the ear cushion skirt away from the earcup*

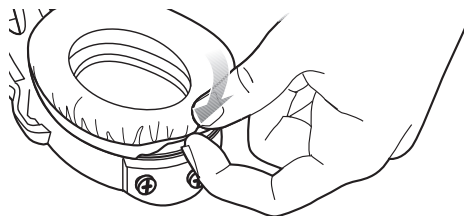

3. Properly position the replacement ear cushion against the earcup.
4. Tuck an edge of the ear cushion skirt into the slot behind the ear cushion flange. Be careful not to fold the skirt over.
5. Work the remainder of the skirt into the slot completely around the earcup.
6. Grasp the ear cushion and adjust its position to remove any folds in the skirt and wrinkles in the cushion.

### **Battery replacement**

1. Turn off ANR.
2. While pushing down, slide the battery door using the finger indent and lift open as shown in Figure 22a.
3. Remove the old batteries.
4. Make sure that the battery compartment contacts are clean.
5. Install two AA alkaline batteries (IEC LR6), as shown in Figure 22b. Use of rechargeable batteries, while possible, will alter the accuracy of the battery power indicator.

**Figure 22**

**a)** Sliding open the battery compartment door

**b)** Inserting new batteries into the control module battery compartment

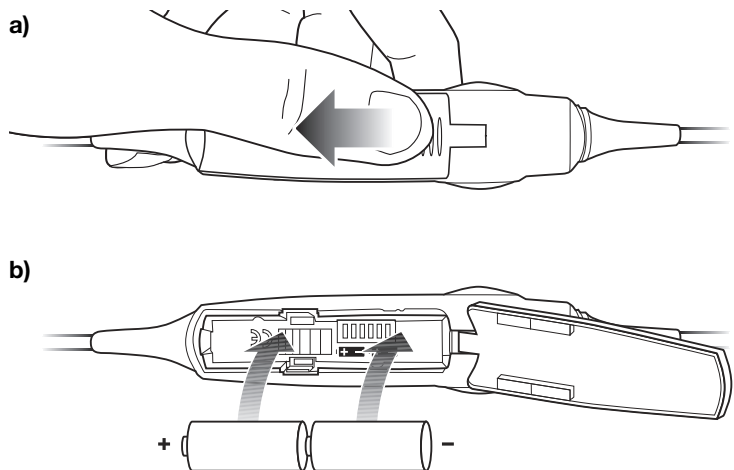

6. Close the battery door.

**⚠ CAUTION:** The battery compartment is designed to prevent inadvertent reverse polarity from installing the batteries incorrectly. If the batteries do not seem to fit correctly, do not force them in. Forcing an improper connection will cause permanent damage to the control module.

**Battery door replacement**

1. Slide the battery door down using the finger indent and lift open.
2. Gently rotate the cover sideways to remove from the control module.
3. Insert new door tab, being careful to insert between the metal spring and plastic housing.

**Headband cushion replacement**

The headband cushion is designed to give the maximum level of comfort to your headset.

Please follow the maintenance instructions below for regular care. Bose recommends that the cushion be replaced after regular care and maintenance fails to restore the wool pile to its original size and shape.

To replace the cushion (Figure 23):

1. On a protected surface, turn the headset upside down. With another person holding the headset open for you, remove the old cushion from the magnesium headband.
2. With the headband still held open, align the center of the new cushion with the center of the headband and press firmly from the center toward the outside.

**Figure 23**

*Removing and attaching the headband cushion*

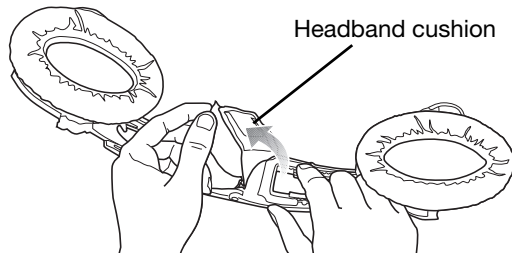

**Note:** *Removing and attaching the headband cushion may be easier if a second person holds the headset open.*

**Boom microphone cable or connector access cover replacement**

Replace the boom microphone cable or connector access cover as described in “Removing an attached boom microphone cable” and “Attaching the boom microphone cable” on page 11.

## *In case of difficulty*

Look for the problem in the left column of the table, then follow the instructions on “What to do” in the right column. If the problem persists, contact the Bose® Aviation Headset Department, using the contact information on page 34 of this guide, for assistance.

<i>Problem</i>	<i>What to do</i>
Communication, but no active noise reduction in either ear	<ul style="list-style-type: none"><li>• Make sure the headset ANR is set to ON.</li><li>• If using aircraft power, check the aircraft fuse or circuit breaker.</li><li>• If using battery power, make sure that the batteries are fresh and correctly installed.</li><li>• Check the battery power indicator. Refer to page 22 for description of LED indicator.</li></ul>
Active noise reduction, but no communication, or very low volume in both ears	<ul style="list-style-type: none"><li>• Check to see if the volume controls are set too low. Refer to “Volume control” on page 21 (battery powered version) or on page 23 (aircraft powered version) for instructions on volume adjustment.)</li><li>• Check the volume setting of intercom/radio.</li><li>• Check the headset aircraft connection.</li><li>• Check stereo/mono configuration switch. See “Changing the optional operation switches” on page 13.</li></ul>
Reduced active noise reduction, intermittent clicking sounds, or communication distortion in a loud environment	<ul style="list-style-type: none"><li>• Check the TriPort® headset openings on the outside of each earcup to ensure they are not blocked. If dust or dirt is present, carefully remove the debris using tweezers. Do not vacuum or blow out debris.</li></ul>
Reduced volume in one ear only	<ul style="list-style-type: none"><li>• Check to see if the volume control is set too low. Refer to “Volume control” on page 21 (battery powered version) or on page 23 (aircraft powered version) for instructions on volume adjustment.</li><li>• Check stereo/mono configuration switch. See “Changing the optional operation switches” on page 13.</li></ul>

Stereo missing or communications in one ear only	<ul style="list-style-type: none"> <li>• If your aircraft has a mono audio system, verify that the stereo/mono configuration switch is set to mono. See “Changing the optional operation switches” on page 13. If the switch is set to stereo, and the headset is plugged into a mono audio system, you will hear only through the left earcup.</li> </ul>
Squealing, whistling, or chirping sound when the system is turned on	<ul style="list-style-type: none"> <li>• Check to see if the protective inner screen is damaged.</li> </ul>
Low rumbling sound with headset turned on in a quiet environment	<ul style="list-style-type: none"> <li>• Adjust the earcup fit to create a better seal on your head. The headset’s low-force design makes it sensitive to items that interfere with the seal around your ear. Make sure that your ears are completely inside the ear cushions, and that a hat or eyeglasses with thick temples do not interfere with the seal.</li> <li>• Check ports at the outside surface of each earcup to ensure they are not blocked. If dust or dirt is present, carefully remove the debris using tweezers. Do not blow out or vacuum debris.</li> <li>• Inspect the seal between the ear cushion skirt and the earcup. The skirt should enclose the earcup evenly, without gaps. Replace any cushions that have surface tears, torn stitching joints, large wrinkles, or have become dried and stiff.</li> </ul>
Crackling sound audible with headset turned on in a loud environment, or ANR is intermittent	<ul style="list-style-type: none"> <li>• Adjust the earcup fit to eliminate the crackling sound. Refer to “Wearing it properly” on page 19.</li> <li>• If your headset is battery powered, check to see if the battery is low (indicated by fast blinking red LED).</li> <li>• If your headset is aircraft powered, make sure that the voltage powering the headset is greater than 10 VDC.</li> <li>• Inspect the seal between the ear cushion skirt and the earcup. The skirt should fit into the slot on the earcup with no gaps. Replace any cushions that have surface tears, torn stitching joints, large wrinkles, or have become dried and stiff.</li> </ul>
No active noise reduction and no communication	<ul style="list-style-type: none"> <li>• Check boom microphone cable connection on the bottom of the earcup.</li> </ul>

**⚠ CAUTION:** Do not attempt to disassemble or service the inside of the earcups or other parts of the headset. Only the boom microphone cable, connector access cover, batteries, battery cover, windscreen, headband cushion, and ear cushions are replaceable by the user. For instructions on how to care for the headset and how to replace the ear cushions, refer to “Headset Care and Maintenance” on page 25.

## TECHNICAL INFORMATION

---

Sound pressure levels (SPL) are relative to 20 micropascals.

<b>Headphone</b>	Damage could occur to avionics equipment that is intended for use only with 600-ohm headsets. If in doubt, consult the avionics equipment manufacturer.
<b>Impedance</b>	Monaural mode: 160 ohms (ON) and 230 ohms (OFF) at 1 kHz Stereo mode: 320 ohms (ON), 460 ohms (OFF)
<b>Frequency response</b>	15 Hz to 15 kHz Sensitivity: 90 dB SPL typical, measured at 1 mw, 1 kHz, full volume on KEMAR ear simulator
<b>Microphone (Electret)</b>	Bias required: 8 to 16 VDC through 220 to 2200 ohms Sensitivity: Varies depending upon bias and radio AC input impedance. Typical output is 600 mV at 114 dB SPL. To assure proper modulation of the radio, it is recommended that an avionics technician adjust its input to match the output of the microphone.
<b>Microphone (Dynamic)</b>	Impedance: 5 ohm or 150 ohm Sensitivity: Equivalent to M-87/M-101
<b>Maximum ambient noise level</b>	115 dBC and 105 dBA SPL
<b>Power source</b>	Battery powered: 2 AA alkaline, IEC LR6 Aircraft powered: 10 to 32 VDC
<b>Battery life</b>	Alkaline: At least 40 hours in typical general aviation aircraft noise. Battery life varies with ambient noise level, temperature, ear cushion condition and age of batteries.
<b>Current</b>	Operating: 25 ma in typical aircraft noise
<b>Fuse/breaker recommended</b>	$\frac{1}{4}$ -amp, fast-blow fuse (AGC $\frac{1}{4}$ -amp fuse) or $\frac{1}{2}$ -amp circuit breaker



<b>Headset weight</b>	12 ounces (340 grams) on the head when cable is supported by the mounting clip
<b>Headset size range</b>	Breadth: 4.8 to 6.3 inches Height: 4.5 to 5.7 inches
<b>Temperature and Altitude (Category A)</b>	Operating: 5 to 131°F (-15 to 55°C) Storage: -67 to 158°F (-55 to 70°C) Altitude: 15,000 feet maximum pressure altitude for full cancellation

## **FAA Technical Standards Order**

The Bose® Aviation Headset X, including its interface, cables, and electret boom microphone, is FAA approved to TSO C-57a and C-58a. It has been designed to function in or withstand exposure to the following environmental conditions:

<u>Condition</u>	<u>Category</u>
AF Conducted Susceptibility	B
Humidity	B
Magnetic effect	B
Power input	B
RF susceptibility	T
Temperature & altitude	A1
Vibration	S & U
Voltage spike	A
Shock drop	12 times, 1m, onto concrete

Environmental categories cited refer to RTCA/DO-160D, July 29, 1997 and DO-214, March 4, 1993.

## **SERVICE & WARRANTY INFORMATION**

---

### ***Warranty period***

Limited 5-year warranty: Bose Corporation warrants this headset to be free from defects in materials and workmanship for a period of five years from the date of purchase. Ear cushion life will vary with use. Ear cushions carry a six-month limited warranty against manufacturer's defects.

### ***Service***

Contact Bose for:

- Spare parts and accessories (see page 35)
- Technical advice
- Installation information
- Warranty and repair information

#### ***To return your headset to Bose for repair***

1. Call to request return authorization instructions from Bose.
2. Clearly mark the return information given to you on the outside of the package.
3. Enclose your name, address, daytime telephone number and e-mail address, along with a description of the problem.
4. Securely pack the headset.
5. We recommend that you insure the headset and use a transport service that provides a tracking number.
6. Send your headset to this address:

### ***Contact information***

Bose Aviation Headset Department  
145 Pennsylvania Avenue  
Framingham, MA 01701-9168 USA  
TEL: 1-800-233-4416 (US)  
508-879-7330, ext. 62006 (outside US)  
FAX: 1-508-766-5997

European Headquarters:  
Noise Reduction Technology Group  
Nijverheidstraat 8 NL-1135 GE Edam  
TEL:+31(0)299-390150  
FAX:+31(0)299-390109  
E-MAIL: aviation\_europe@bose.com  
World Wide Web: www.bose.com

## ***Ordering parts and accessories***

The following accessories and customer-replaceable components may be purchased directly from Bose. Refer to contact information on page 34.

- Additional control module cable  
Specify: battery powered; or aircraft powered
- Ear cushions
- Carry bag
- Windscreen with attachment band
- Aircraft panel connector installation kit
- Battery door
- Fleece headband cushion
- Clothing clip



325239-0010

***BOSE***<sup>®</sup>  
*Better sound through research*<sup>®</sup>

©2009 Bose Corporation, The Mountain,  
Framingham, MA 01701-9168 USA  
AM325239 Rev.00